

Flare™

48MP CAMERAS

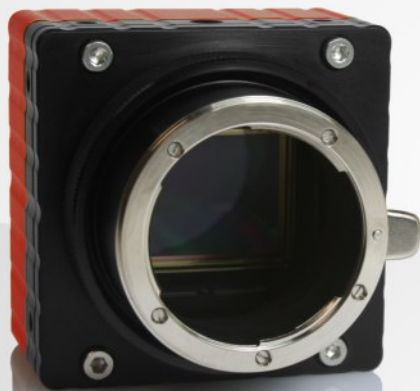

CoaxPress

Video cameras with CMOSIS CMV50000 Sensors

APPLICATIONS

Automated Inspection

Aerial Imaging and Mapping

Wide Area Surveillance

Specialty Video Production



FEATURES INCLUDE:

- Monochrome and Colour Models
- Global Shutter CMOS with CDS
- CoaxPress Output
- Selectable 8/10/12-bit Data Formats
- Multiple Lens Mount Options
- Compact Size, Low-Power Fanless Design
- Multi-ROI with up to 10 Separate Windows
- Auto Exposure and Auto White Balance

IOI
IO INDUSTRIES

SPECIFICATIONS

Camera Model	Flare 48MP
Sensor Size (H x V)	7920 x 6004 (47.5MP)
Frame rate (full resolution)	30.9 fps
Optical Format	35mm Full Frame (45.7mm diagonal)
Sensor Type	CMOS w. global electronic shutter
Sensor Options	Monochrome or color (Bayer)
Pixel Size	4.6 x 4.6 μ m
Dynamic Range / Sensitivity	64 dB, 4 V/lux.s
Output Configurations	1/2/4 links at 2.50Gbps (CXP-2), 3.125Gbps (CXP-3), 5.0Gbps (CXP-5) or 6.25Gbps (CXP-6)
Multiple ROI	Up to 10 separate windows
Pixel Bit Depth	8/10/12-bit
Exposure Control	Trigger width, timed, or auto-exposure control
Image Correction	Black level, row and column-based FPN/PRNU, bad pixel replacement, flat field correction
Color Processing	Auto white balance (tracking or manual), programmable LUTs
Camera Configuration	GenICam or Flare Control software
Mechanical/Electrical	
Dimensions	79.7 mm x 79.7 mm x 78.0 mm (WxHxD, with F-mount)
Lens Mount	F-mount, M58 x 0.75, Active Canon EF, others upon request
Weight	610g (with F-mount, no lens)
Power Requirements	7.9W, 7-26V DC via Hirose 12-pin or 24V via PoCXP
Additional I/O (Hirose 12-pin)	TTL-level trigger input/output
Operating Temperature	-30°C to 45°C, 20-85% humidity (non-condensing)
Storage Temperature	-40°C to 85°C, 10-90% humidity (non-condensing)

ORDERING

Example: 48M30MCX-F

Camera 48M30	Lens Type F - F-mount M - M58 x 0.75 A - Active EF-mount
Sensor Type M - Monochrome C - Color (with IR filter)	Interface CX - CoaXPress

FRAME RATE CHART

Full-Resolution Frame Rate by Connection and Bit Depth	48M30xCX		
	8-bit	10-bit	12-bit
4x CXP-6	30.9	30.9	30.9
4x CXP-5	30.9	29.2	24.3
4x CXP-3	23.5	18.9	15.6
4x CXP-2	18.8	15.2	12.4
2x CXP-6	23.5	18.9	15.6
2x CXP-5	18.2	14.6	12.2
2x CXP-3	11.7	9.5	7.8
2x CXP-2	9.4	7.6	6.2
1x CXP-6	11.7	9.5	7.8
1x CXP-5	9.1	7.3	6.1
1x CXP-3	5.9	4.7	3.9
1x CXP-2	4.7	3.8	3.1

MECHANICAL DIAGRAMS

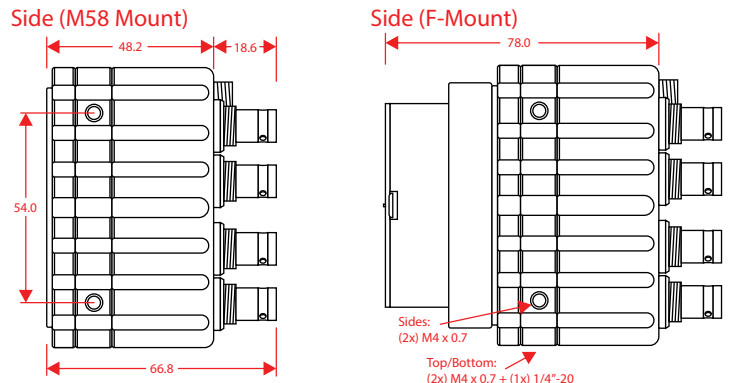
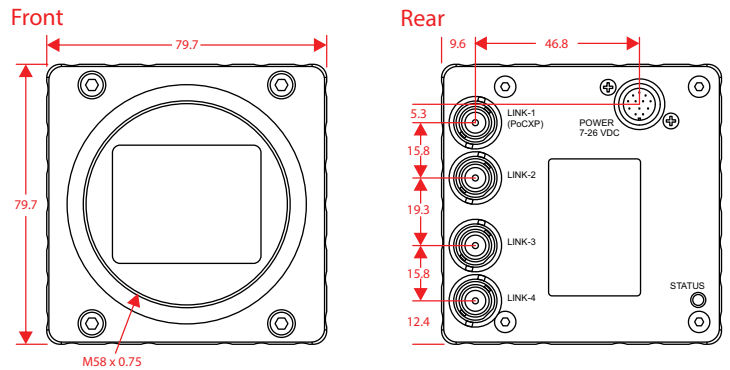

Visit us at: www.ioindustries.com
 15940 Robin's Hill Road
 London, Ontario, Canada, N5V 0A4
 Tel: +1 519 663 9570
 Email: sales@ioindustries.com

LET'S STAY CONNECTED!



@IOINDUSTRIES



@IOINDUSTRIES



@IO-INDUSTRIES

Copyright © 2017 IO Industries Inc. Flare is a trademark of IO Industries.
 All other trademarks are the property of their respective owners.

Datasheet Rev. 1.4 (09/06/2017)
 Specifications subject to change without notice